



**SYSTEM
DECOR**

Ceramica
VOGUE

System Decor è il nuovo sistema di decori in gres smaltato ingelivo di Ceramica Vogue, coordinato dallo studio Marcante – Testa, per rispondere ai differenti usi della ceramica in architettura sia per gli spazi interni che per quelli esterni.

System Decor interpreta, partendo da considerazioni spaziali, il mondo del colore e della decorazione delle superfici dando vita al naturale complemento di System, la collezione più iconica dell'azienda.

Le diverse combinazioni del modulo triangolare 10x10x14 cm, montate su rete, utilizzano l'intera palette colori del System per sviluppare decori geometrici capaci di caratterizzare ogni ambiente, residenziale ed extra residenziale, anche attraverso le innumerevoli possibilità di posa che il sistema mette a disposizione.

System Decor rappresenta una soluzione altamente versatile e perfettamente abbinabile alle tinte unite del System dove le finiture lucide della gamma trasparenze e quelle opache della linea Interni aiutano a instaurare dei rapporti diversi con lo spazio circostante, conferendo al prodotto ceramico un importante ruolo di definizione qualitativa dell'ambiente architettonico.

System Decor refers to the new frost-resistant glazed stoneware range of decors by Ceramica Vogue, carried out by Marcante-Testa studio, to meet the even more different ceramic applications in architecture, both in indoor and outdoor settings.

On the base of deep insights into the space around, System Decor simply interprets the world of colour and surfaces decoration leading to a natural complement of System, the most iconic collection of the company.

The various possible layouts given by the meshmounted triangular module 10x10x14 cm exploit the entire System color palette, thus creating geometric patterns able to feature any kind of environment, residential and extra residential as well, thanks to the countless laying schemes that this series leads to.

Decor System stands for a really highly versatile solution also because it's perfectly matchable with System plain colors where trasparenze glossy finishes and Interni satin ones contribute to establishing different links to the space around, lending to the ceramic product a significant role for expressing the quality of the architectural context.

System Decor est le nouveau système de décors en grès émaillé ingélif de Ceramica Vogue, coordonné par le studio Marcante - Testa, pour répondre aux différentes utilisations de la céramique en architecture pour les espaces intérieurs et extérieurs.

System Decor interprète, à partir de considérations spatiales, le monde de la couleur et de la décoration des surfaces donnant vie au complément naturel de System, la collection la plus emblématique de l'entreprise.

Les différentes combinaisons du module triangulaire 10x10x14 cm, montées sur trame, utilisent toute la palette de couleurs du System pour développer des décors géométriques capables de caractériser chaque pièce, résidentielle et extra résidentielle, également à travers les innombrables possibilités de pose que le système met à disposition.

System Decor représente une solution très versatile et parfaitement assortie aux teintes unies du System où les finitions brillantes de la gamme trasparenze et celles mat de la ligne Interni aident à établir des rapports différents avec l'espace environnant, en conférant au produit céramique un rôle important de définition qualitative de l'environnement architectural.

System Decor ist das neue frostsichere Dekorationssystem aus glasiertem Steinzeug von Ceramica Vogue, das vom Studio Marcante - Testa koordiniert wird, um auf die unterschiedlichen Verwendungen von Keramik in der Architektur für Innen- und Außenbereiche zu reagieren.

System Decor interpretiert ausgehend von räumlichen Überlegungen die Welt der Farb- und Oberflächendekoration und belebt die natürliche Ergänzung von System, der bekanntesten Kollektion des Unternehmens.

Die verschiedenen Kombinationen des dreieckigen Moduls 10x10x14 cm, das auf dem Netz montiert ist, verwenden die gesamte Farbpalette des Systems, um geometrische Dekorationen zu entwickeln, die jede Umgebung, Wohn- und Offen, charakterisieren können, auch durch die unzähligen Verlegungsmöglichkeiten, die das System bietet.

Das Dekorsystem stellt eine äußerst vielseitige Lösung dar, die perfekt mit den Volltonfarben des Systems kombiniert werden kann, wobei die glänzenden Oberflächen der trasparenze-Reihe und die matte Oberflächen der Interni-Linie dazu beitragen, unterschiedliche Beziehungen zum umgebenden Raum herzustellen, wodurch das Keramikprodukt eine wichtige Rolle bei der Definition der Qualität des architektonischen Umfelds spielt.

2	Introduzione/Introduction/Introduction/Einführung
4	Galleria immagini/Image gallery/Galerie d'images/Bildergalerie
28	SYSTEM DECOR 1 Finitura satinata/Matt finishing/Finition satinée/Satinierte Oberfläche Finitura lucida/Gloss finishing/Finition brillante/Glänzende Oberfläche Finitura satinata-lucida/Matt-Gloss finishing/Finition satinée-brillante/ Satinierte-Glänzende Oberfläche
34	SYSTEM DECOR 2 Finitura satinata/Matt finishing/Finition satinée/Satinierte Oberfläche
46	Schede tecniche/Technical charts/Fiches techniques/Technische Informationen





Rivestimento/Wall/Revêtement de mur/Wandfliesen:
TR Cipria 10x20 cm - Quadra 2,5x20 cm
Giunto/Joint/Fugen/Joint::
Mapei 139 Pink Powder

Soffitto/Ceiling/Plafond/Decke:
System Decor 2 MT D4 001
(IN Granata - IN Cipria 10x10x14 cm)
Giunto/Joint/Fugen/Joint:
Mapei 143 Terracotta



Rivestimento/Wall/Revêtement de mur/Wandfliesen:
TR Ferro 10x10x14 cm - 10x10 cm
Giunto/Joint/Joint/Fuge:
Mapei 110 Manhattan 2000

Pavimento/Floor/Revêtement de sol/Bodenbelag:
System Decor 2 MT D1 003
(IN Seta - IN Nero 10x10x14 cm)
Giunto/Joint/Joint/Fuge:
Mapei 120 Black





Rivestimento/Wall/Revêtement de mur/Wandfliesen:
TR Turchese 5x40 cm
Giunto/Joint/Joint/Fuge:
Mapei 171 Turquoise

Pavimento/Floor/Revêtement de sol/Bodenbelag:
System Decor 2 MT D2 004
(IN Malachite - IN Turchese 10x10x14 cm)
Giunto/Joint/Joint/Fuge:
Mapei 171 Turquoise





WINE BAR

BIANCHI	
GEWURZTRAMINER	€ 8,00
PINOT GRIGIO	€ 6,00
RIBOLLA GIALLA COLLIO	€ 7,00
SOAVE CLASSICO	€ 7,00
LAGANA DOC	€ 8,00
GAVI DOCG	€ 8,00
ROSSI	
CABERNET FRANC	€ 8,00
CHIANTI CLASSICO DOCG	€ 6,00
MORELLINO DI SCASANO	€ 7,00
PRIMITIVO SALENTO	€ 7,00
NERO D'AVOLA	€ 8,00
BOLLE	
PROSECCO DOCG	€ 6,00



Rivestimento/Wall/Revêtement de mur/Wandfliesen:
 IN Cipria 10x10 cm - 20x20 cm - Quadra 2,5x20 cm
 In Cipria cod N 2,5x20 cm - cod F 2,5x2,5 cm
 TR Granata 10x10x14 cm
 Giunto/Joint/Joint/Fuge:
 Mapei 139 Pink Powder

Soffitto/Ceiling/Plafond/Decke:
 TR Perla 5x5 cm
 Giunto/Joint/Fugen/Joint:
 Mapei 112 Medium Gray
 Pavimento/Floor/Revêtement de sol/Bodenbelag:
 System Decor 2 MT D2 002
 (IN Granata - IN Cipria 10x10x14 cm)
 Giunto/Joint/Joint/Fuge:
 Mapei 143 Terracotta



SÉE





Rivestimento/Wall/Revêtement de mur/Wandfliesen:
System Decor 2 MT D3 001
(IN Argento - IN Cipria 10x10x14 cm)
IN Cipria Quadra 2,5x20 cm
Giunto/Joint/Joint/Fuge:
Mapei 110 Manhattan 2000

Rivestimento/Wall/Revêtement de mur/Wandfliesen:
TR Seta 5x40 cm
IN Latte 20x40 cm
Giunto/Joint/Joint/Fuge:
Mapei 131 Vanilla

Soffitto/Ceiling/Plafond/Decke:
TR Seta 5x20 cm
Giunto/Joint/Fugen/Joint:
Mapei 131 Vanilla

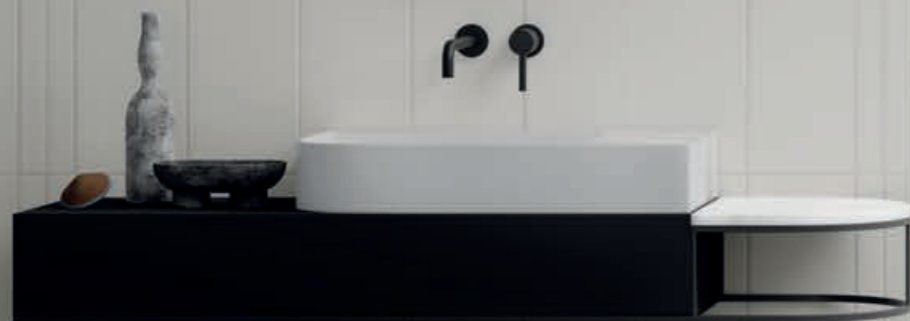

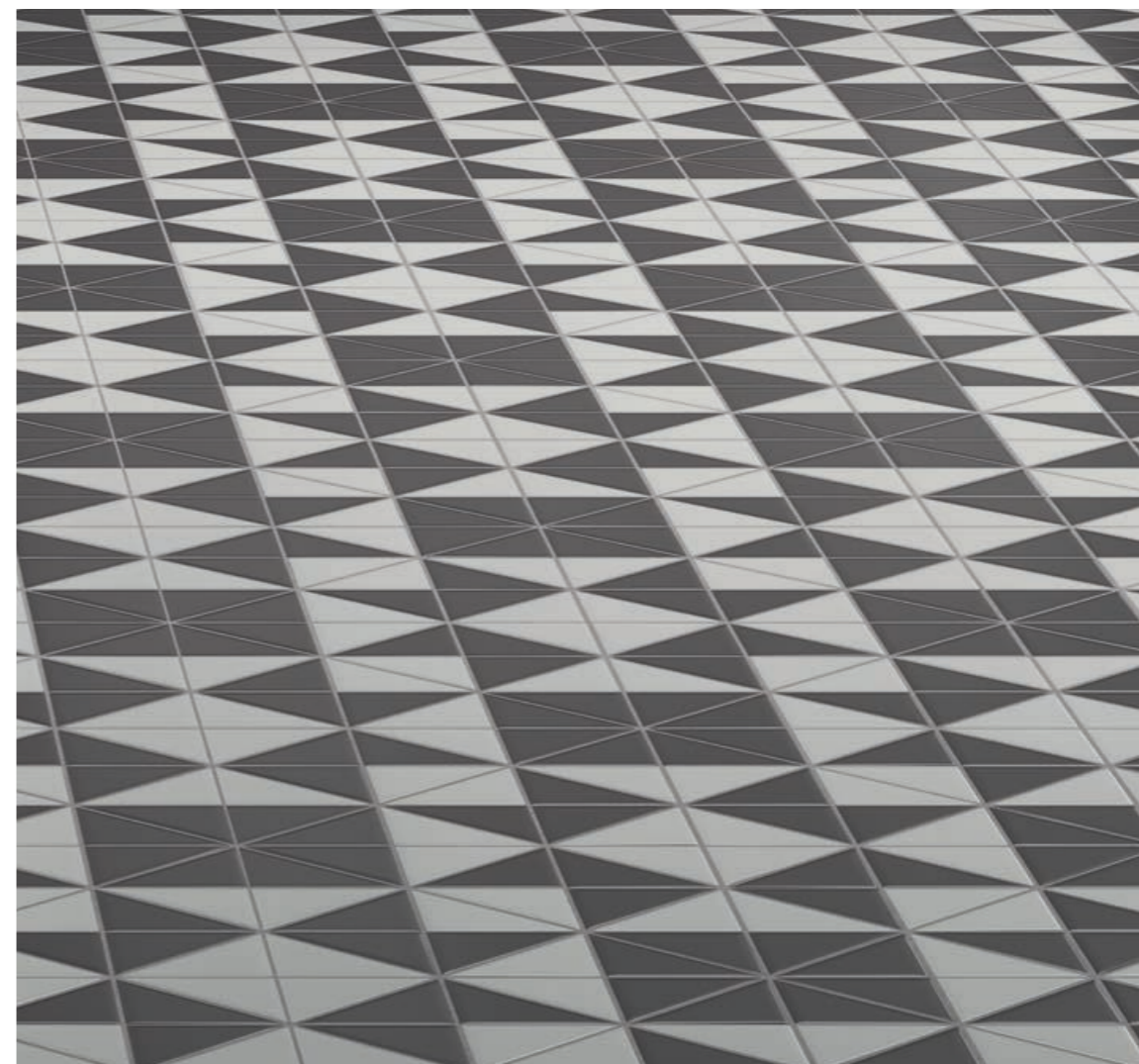

Rivestimento/Wall:
IN Ghiaccio 20x40 cm - 5x40 cm - Quadra 2,5x20 cm
Giunto/Joint:
Mapei 100 White

Pavimento/Floor:
System Decor 2 MT D1 002
(IN Ferro - IN Argento 10x10x14 cm)
Giunto/Joint:
Mapei 110 Manhattan 2000



FLOOR 3

35

36

37

Rivestimento/Wall/Revêtement de mur/Wandfliesen:
IN Ceruleo 10x20 cm - cod. K 2,5x10 cm
System Decor 1 MT SR 002
(TR Petrolio - IN Ceruleo)
Giunto/Joint/Joint/Fuge:
Mapei 110 Manhattan 2000

Rivestimento/Wall/Revêtement de mur/Wandfliesen:
IN Ghiaccio 10x20 cm
Giunto/Joint/Joint/Fuge:
Mapei 100 White

SYSTEM DECOR 1

FINITURA: satinata

UTILIZZO: interni ed esterni, pavimenti e rivestimenti

FINISHING: matt

USE: internal and external, flooring and covering

FINITION: satinée

UTILISATION: intérieur et extérieur, sols et murs

OBERFLÄCHENAUSFÜHRUNG: Satinende

EINSATZ: Innen und Außen, Böden und Wände

FINITURA: lucida

UTILIZZO: interni ed esterni, rivestimenti

FINISHING: glossy

USE: internal and external, covering

FINITION: brillante

UTILISATION: intérieurs et extérieurs, revêtements

OBERFLÄCHENAUSFÜHRUNG: glänzend

EINSATZ: Innen-und Außenbereiche, Wandverkleidungen

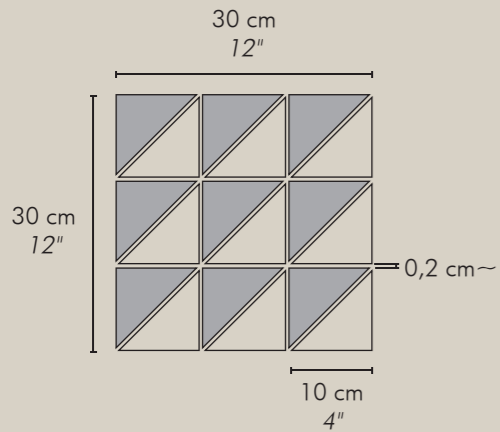

Montato su rete in fibra di vetro
Meshmounted on fibreglass net
Collé sur trame en fibre de verre
Auf Glasfasernetz geklebt

SYSTEM DECOR 1

COLORI

COLORS

COULEURS

FARBEN

FINITURA SATINATA-LUCIDA/INTERNI (IN)-TRASPARENZE (TR)

MATT-GLOSSY FINISHING/ INTERNI (IN)-TRASPARENZE (TR)

FINITION SATINÉE-BRILLANTE/INTERNI (IN)-TRASPARENZE (TR)

SATINIERT-GLÄNZENDE OBERFLÄCHE/INTERNI (IN)-TRASPARENZE (TR)



MT SR 001

TR MALACHITE
IN TURCHESE

Kerakoll 49 Muschio

Mapei 171 Turquoise



MT SR 002

TR PETROLIO
IN CERULEO

Mapei 174 Tornado

GIUNTI
JOINTS SUGGESTION
JOINTS
FUGE

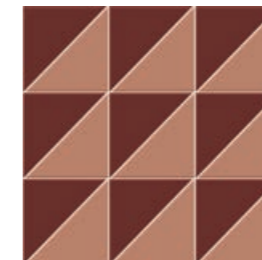

MT SR 003

TR GRANATA
IN CIPRIA

Mapei 139 Pink Powder

Mapei 143 Terracotta

GIUNTI
JOINTS SUGGESTION
JOINTS
FUGE

SYSTEM DECOR 1

COLORI
COLORS
COULEURS
FARBEN

FINITURA SATINATA/INTERNI (IN)
MATT FINISHING/ INTERNI (IN)
FINITION SATINÉE/INTERNI (IN)
SATINIERTE OBERFLÄCHE/INTERNI (IN)

FINITURA LUCIDA/TRASPARENZE (TR)
GLOSSY FINISHING/TRASPARENZE (TR)
FINITION BRILLANTE/TRASPARENZE (TR)
GLÄNZENDE OBERFLÄCHE/TRASPARENZE (TR)

SYSTEM DECOR 1

COLORI
COLORS
COULEURS
FARBEN

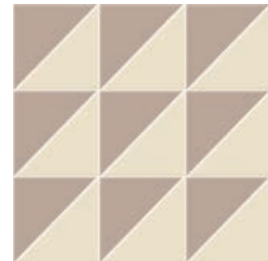

MT SI 001
IN TORTORA
IN SETA



MT SI 002
IN FERRO
IN ARGENTO

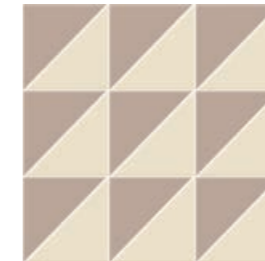

MT ST 001
TR TORTORA
TR SETA

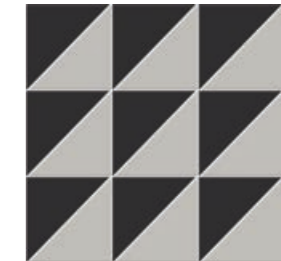

MT ST 002
TR FERRO
TR ARGENTO

GIUNTI
JOINTS SUGGESTION
JOINTS
FUGE

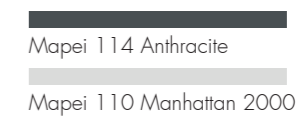
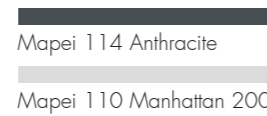

GIUNTI
JOINTS SUGGESTION
JOINTS
FUGE

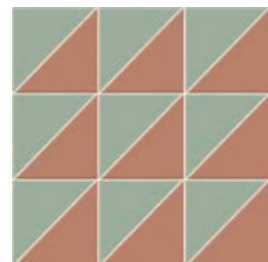

MT SI 003
IN MASTICE
IN CIPRIA



MT SI 004
IN GHIACCIO
IN NERO

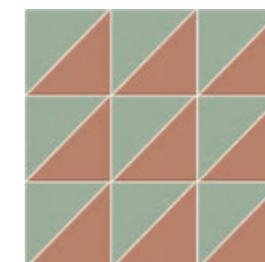

MT ST 003
TR MASTICE
TR CIPRIA



MT ST 004
TR GHIACCIO
TR NERO

GIUNTI
JOINTS SUGGESTION
JOINTS
FUGE

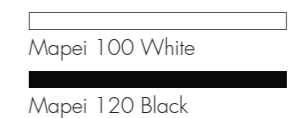
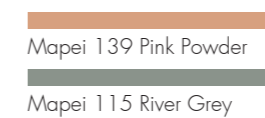
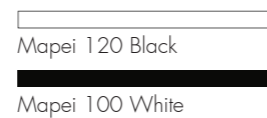
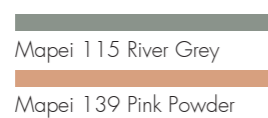

GIUNTI
JOINTS SUGGESTION
JOINTS
FUGE

SYSTEM DECOR 1

SCHEMI DI POSA
INSTALLATION CONFIGURATIONS
SCHÉMAS DE POSE
VERLEGESCHEMAS

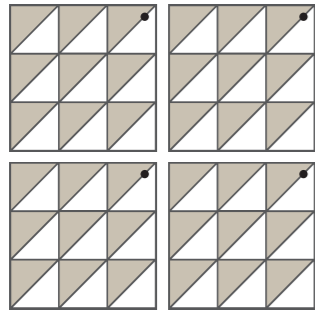

POSA A

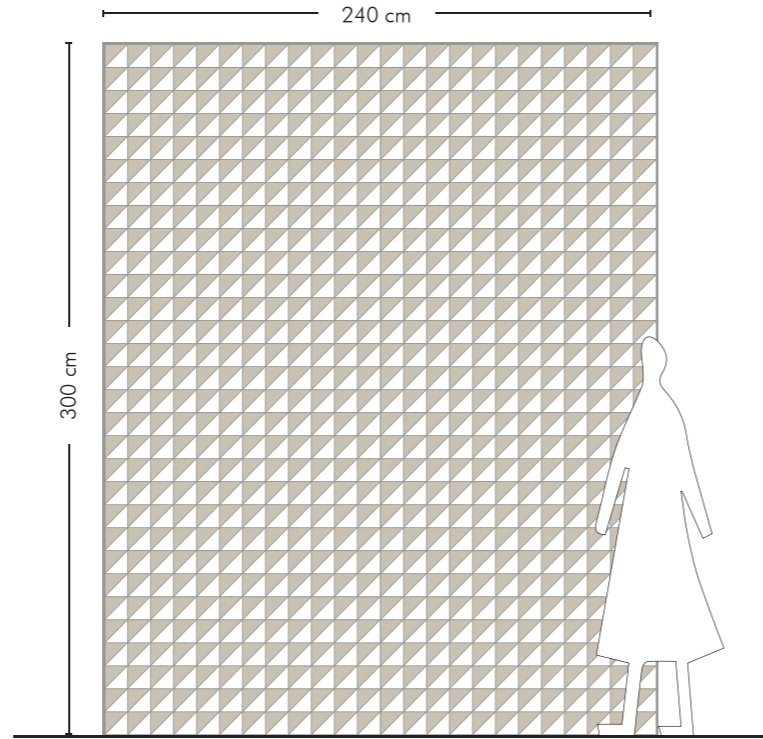

POSA A

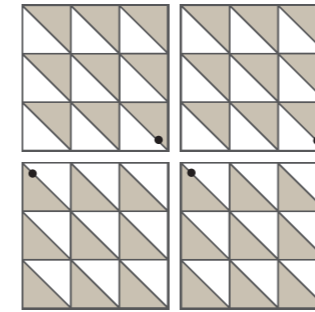

POSA C (PAG. 26-27)

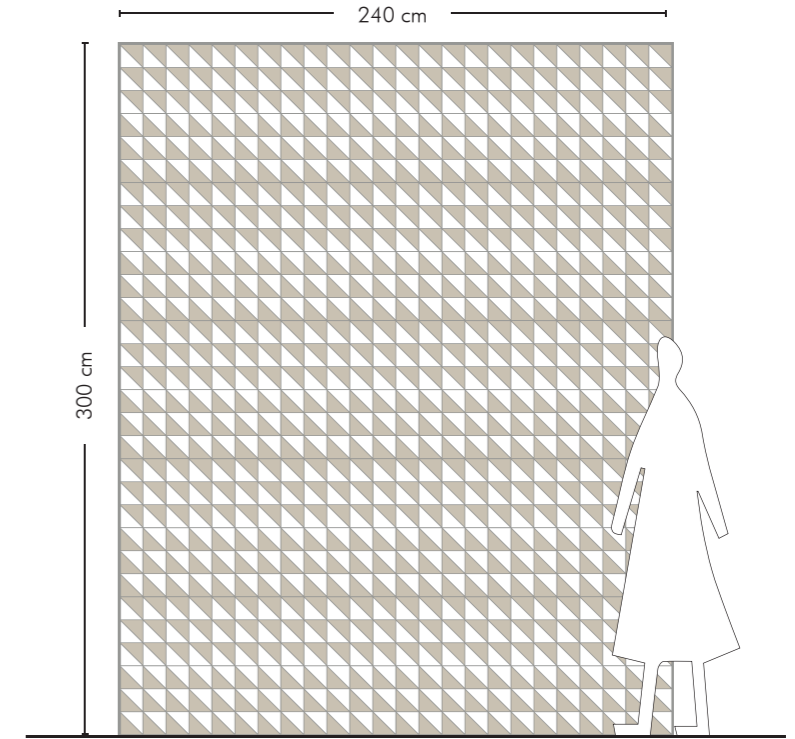

POSA C (PAG. 26-27)

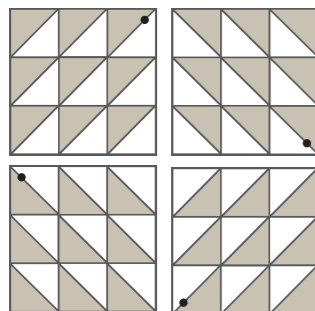

POSA B

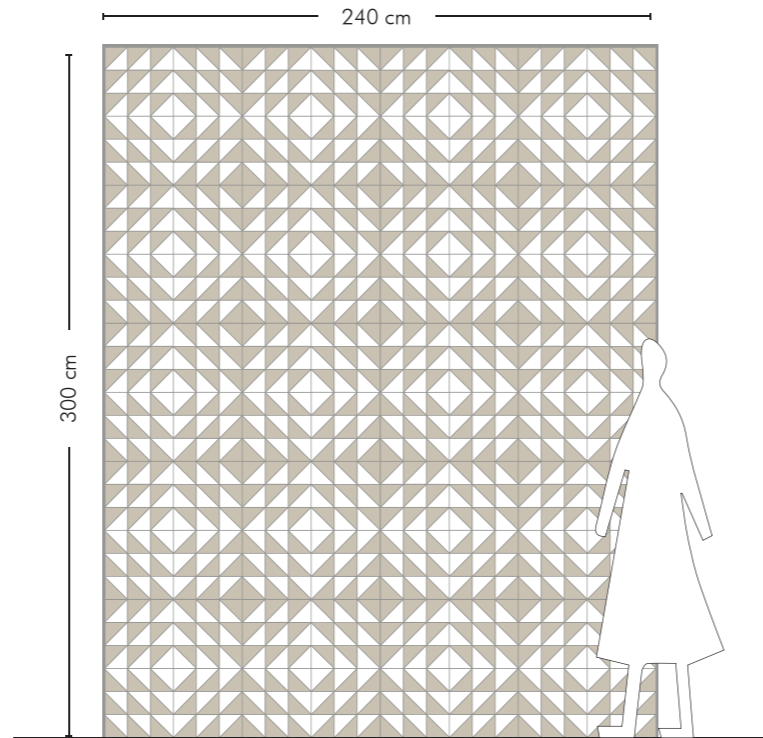

POSA B

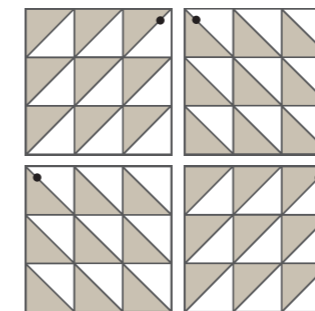

POSA D

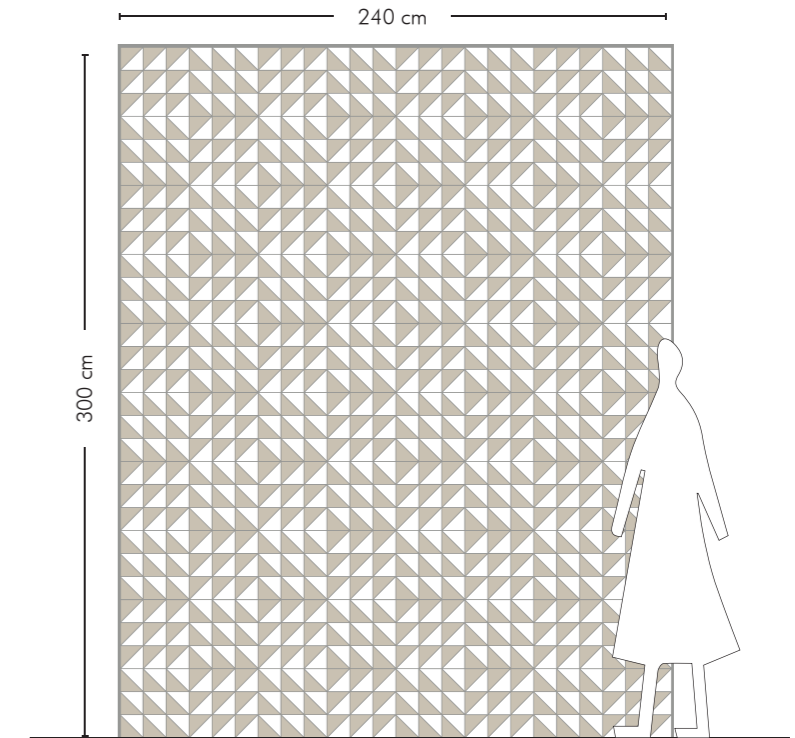

POSA D

SYSTEM DECOR 2

FINITURA: satinata

UTILIZZO: interni ed esterni, pavimenti e rivestimenti

FINISHING: matt

USE: internal and external, flooring and covering

FINITION: satinée

UTILISATION: intérieur et extérieur, sols et murs

OBERFLÄCHENAUSFÜHRUNG: Satinende

EINSATZ: Innen und Außen, Böden und Wände

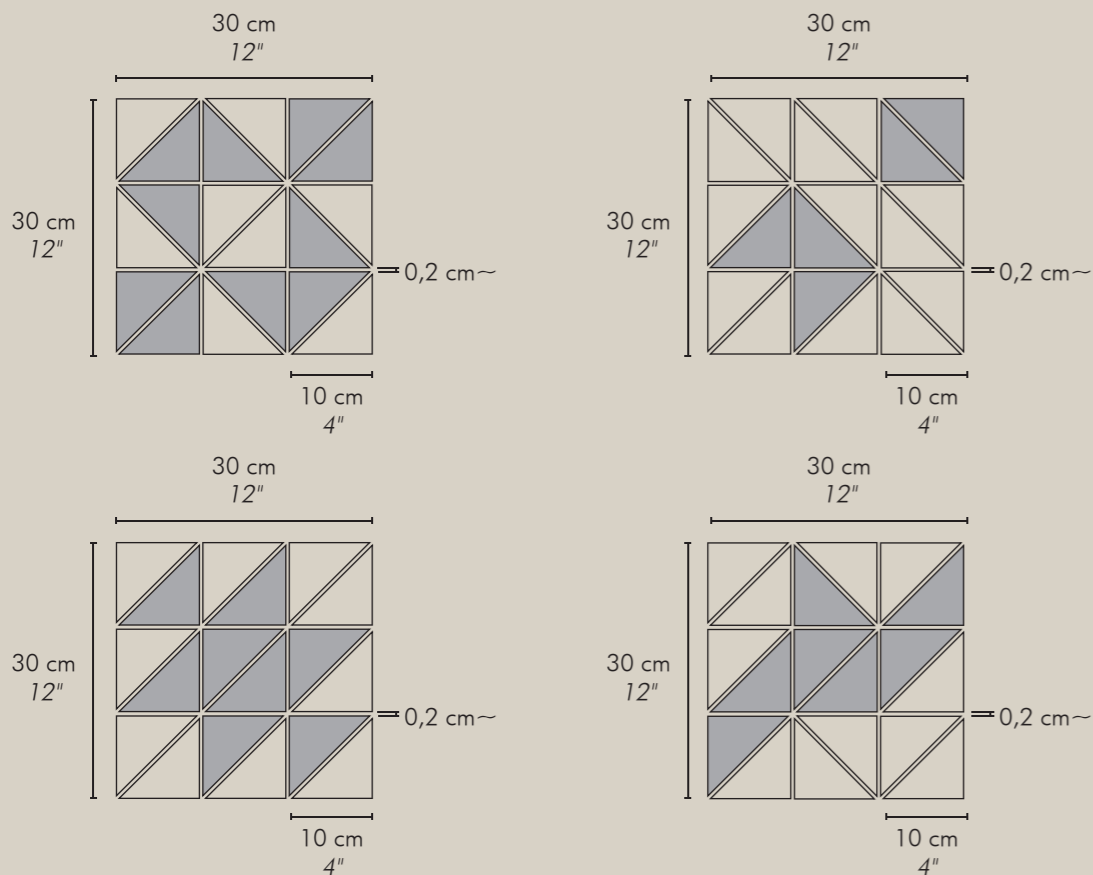

Montato su rete in fibra di vetro
Meshmounted on fibreglass net
Collé sur trâme en fibre de verre
Auf Glasfasernetz geklebt

SYSTEM DECOR 2

COLORI

COLORS

COULEURS

FARBEN



MT D1 001

IN SENAPE
IN PERLA

Kerakoll 56 Acer

Mapei 112 Medium Grey



MT D1 002

IN FERRO
IN ARGENTO

Mapei 114 Anthracite

Mapei 110 Manhattan 2000

GIUNTI
JOINTS SUGGESTION
JOINTS
FUGE



MT D1 003

IN SETA
IN NERO

Mapei 131 Vanilla

Mapei 120 Black



MT D1 004

IN SETA
IN TORTORA

Mapei 131 Vanilla

Mapei 133 Sand

GIUNTI
JOINTS SUGGESTION
JOINTS
FUGE

SYSTEM DECOR 2

COLORI
COLORS
COULEURS
FARBEN



MT D2 001
IN MASTICE
IN NERO

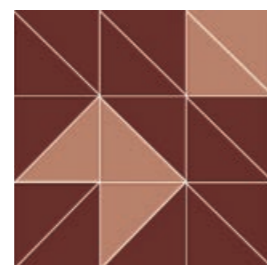
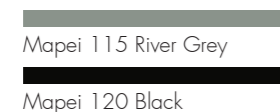

MT D2 002
IN GRANATA
IN CIPRIA

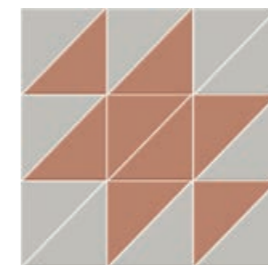
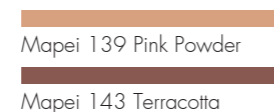

MT D3 001
IN ARGENTO
IN CIPRIA

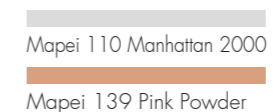

MT D3 002
IN SETA
IN MALACHITE

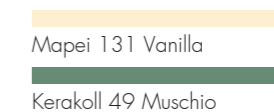

GIUNTI
JOINTS SUGGESTION
JOINTS
FUGE

GIUNTI
JOINTS SUGGESTION
JOINTS
FUGE



MT D2 003
IN PETROLIO
IN SETA

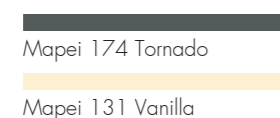

MT D2 004
IN MALACHITE
IN TURCHESE

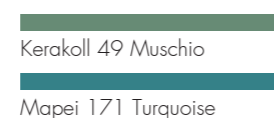

GIUNTI
JOINTS SUGGESTION
JOINTS
FUGE

GIUNTI
JOINTS SUGGESTION
JOINTS
FUGE

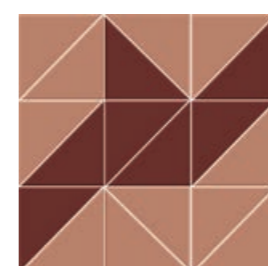

MT D4 001
IN GRANATA
IN CIPRIA



MT D4 002
IN MALACHITE
IN MASTICE

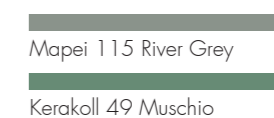

SYSTEM DECOR 2

COLORI
COLORS
COULEURS
FARBEN

SYSTEM DECOR 2

SCHEMI DI POSA
INSTALLATION CONFIGURATIONS
SCHÉMAS DE POSE
VERLEGESCHEMAS

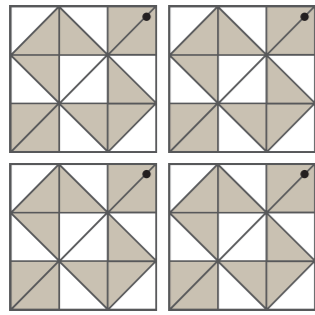

POSA A

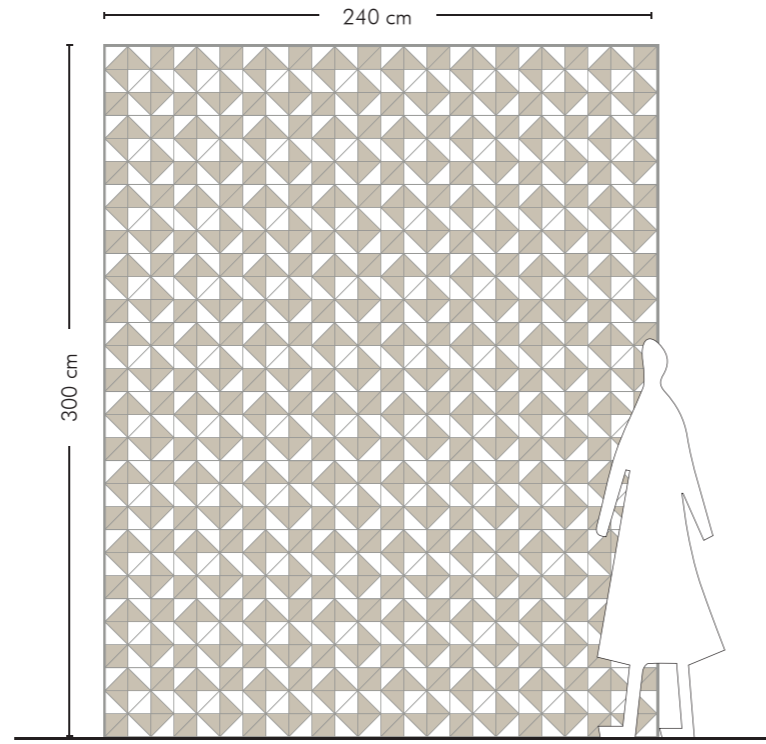

POSA A

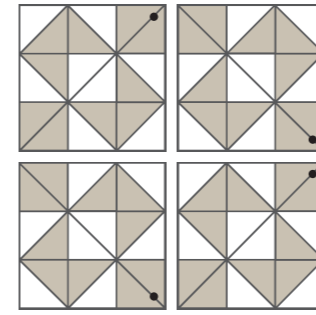

POSA C (PAG. 8-9/22-23)

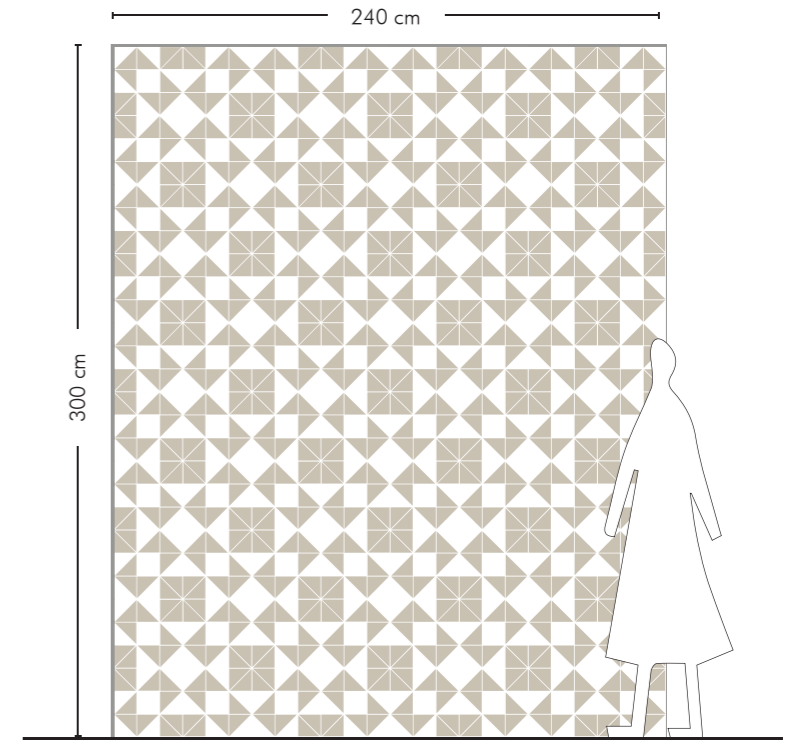

POSA C (PAG. 6-7/22-23)

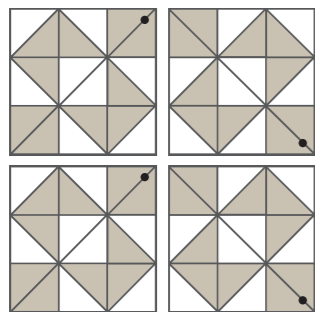

POSA B

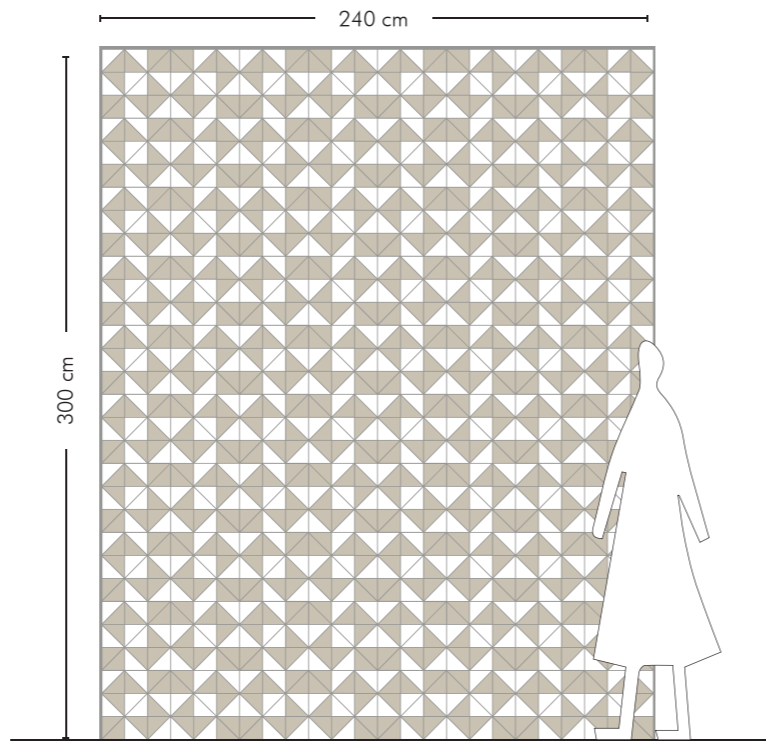

POSA B

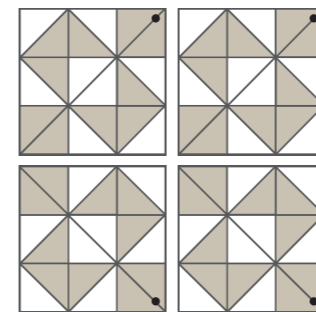

POSA D

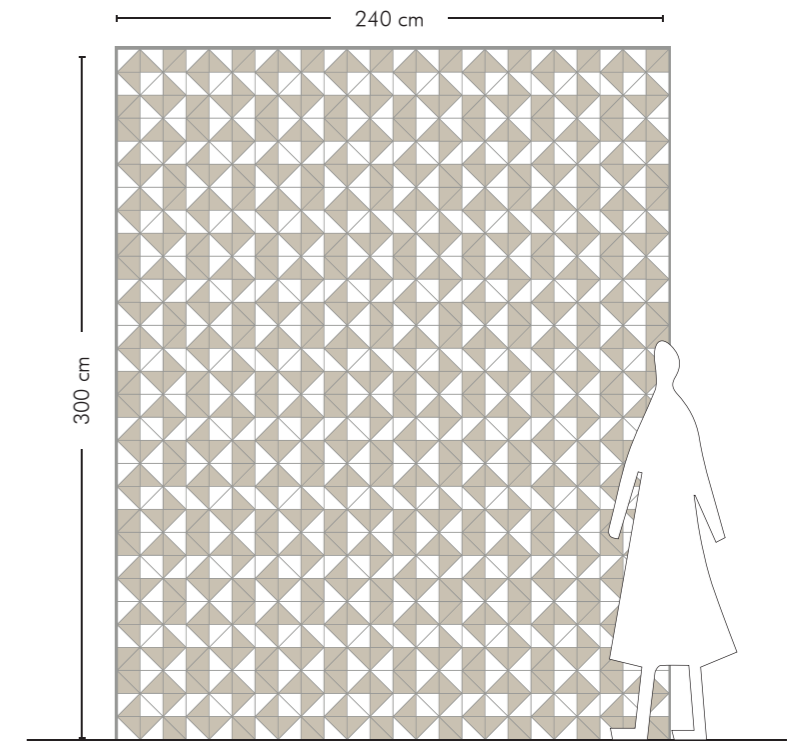

POSA D

SYSTEM DECOR 2

SCHEMI DI POSA
 INSTALLATION CONFIGURATIONS
 SCHÉMAS DE POSE
 VERLEGESCHEMAS

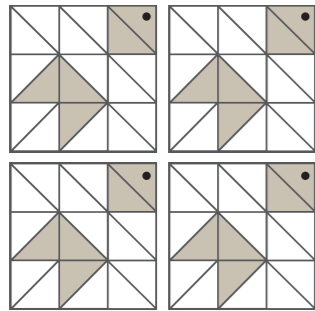

POSA A

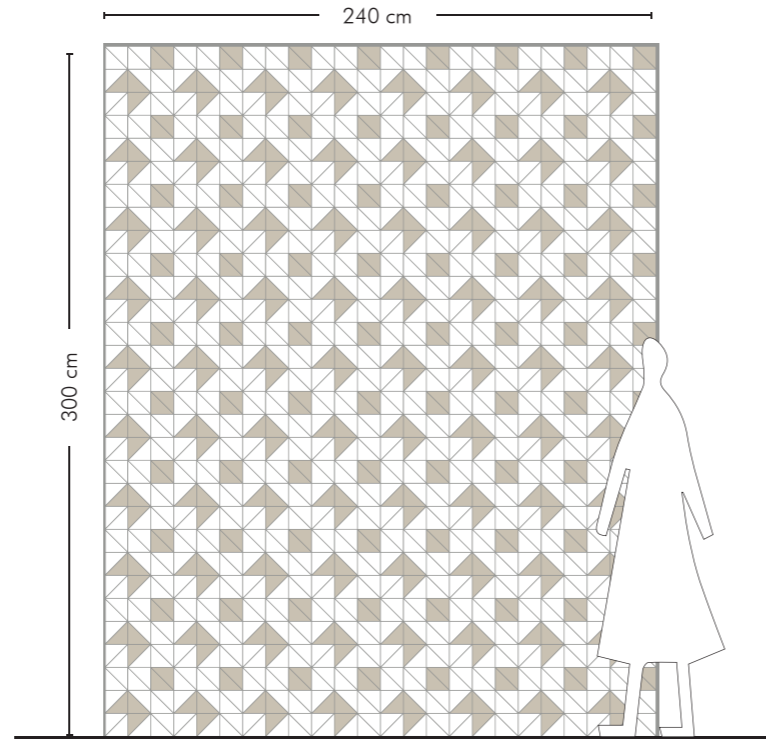

POSA A

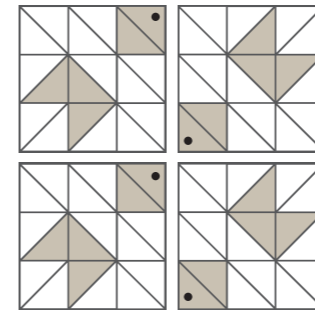

POSA C (PAG. 14-15)

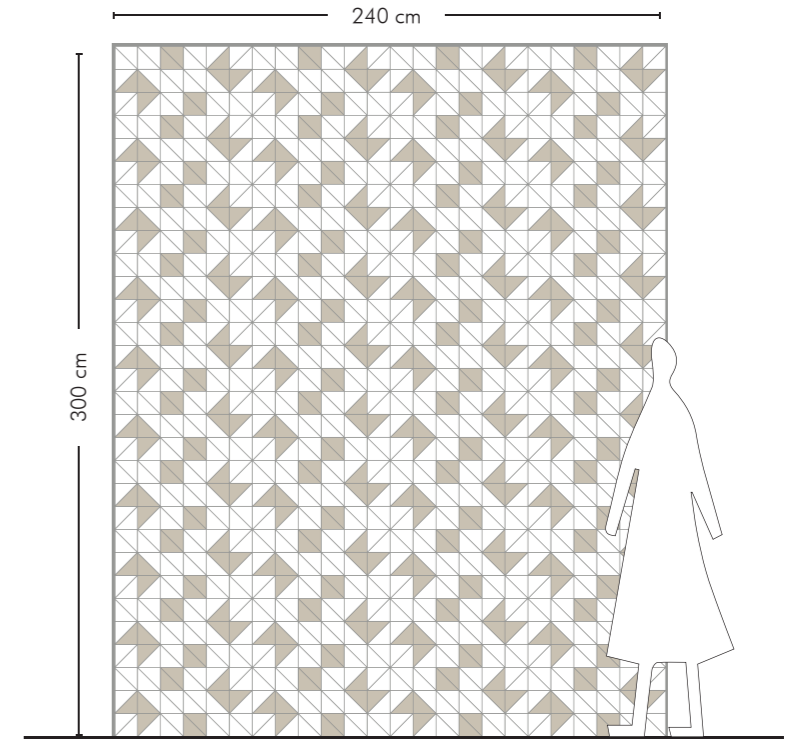

POSA C (PAG. 14-15)

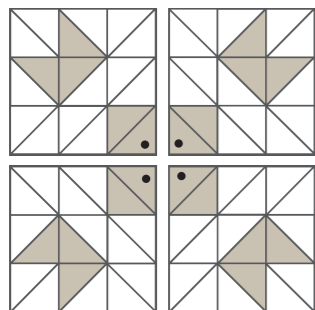

POSA B (PAG. 10-11)

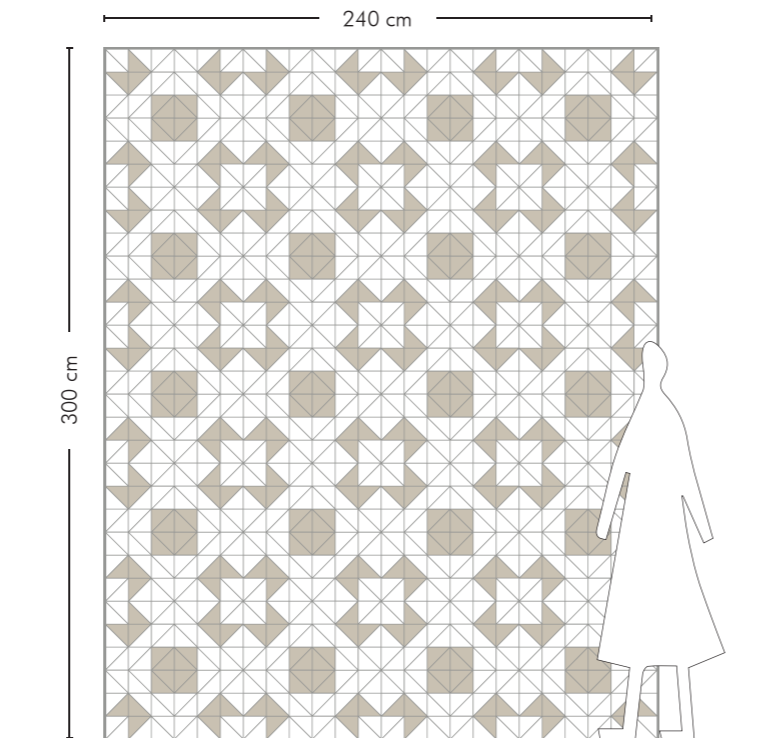

POSA B (PAG. 18-19)

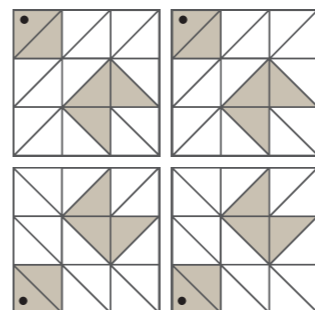

POSA D

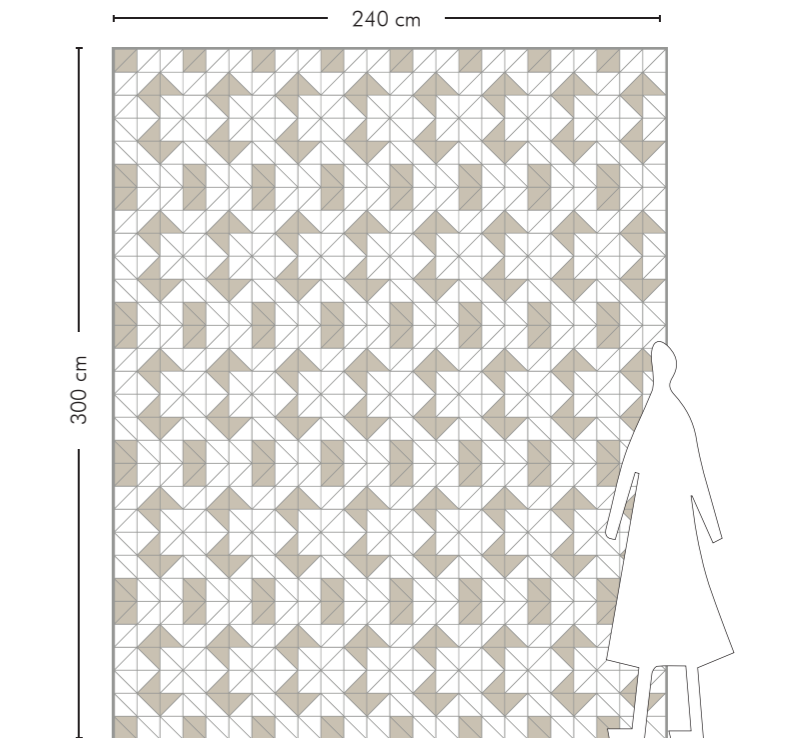

POSA D

SYSTEM DECOR 2

SCHEMI DI POSA
INSTALLATION CONFIGURATIONS
SCHÉMAS DE POSE
VERLEGESCHEMAS

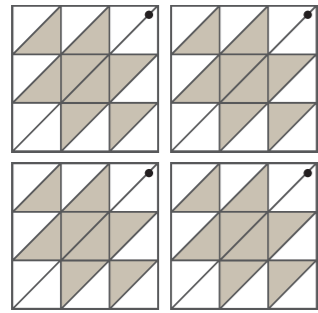

POSA A (PAG. 18-19)

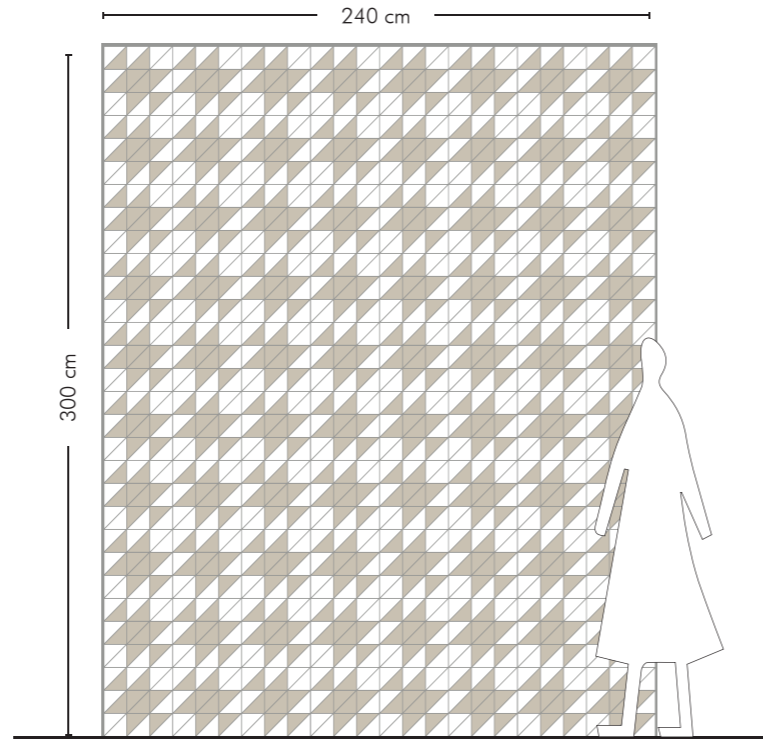

POSA A (PAG. 10-11)

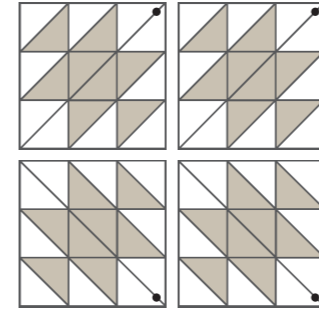

POSA C

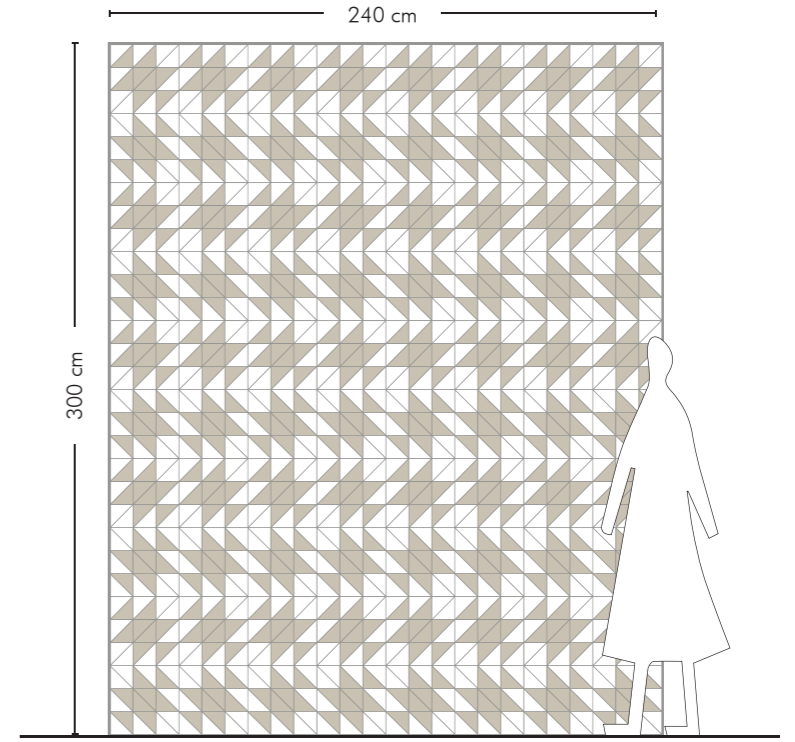

POSA C

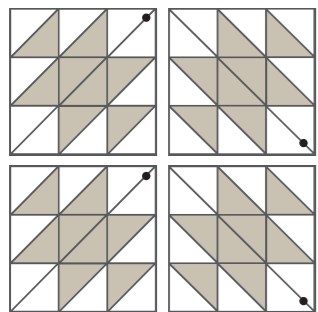

POSA B

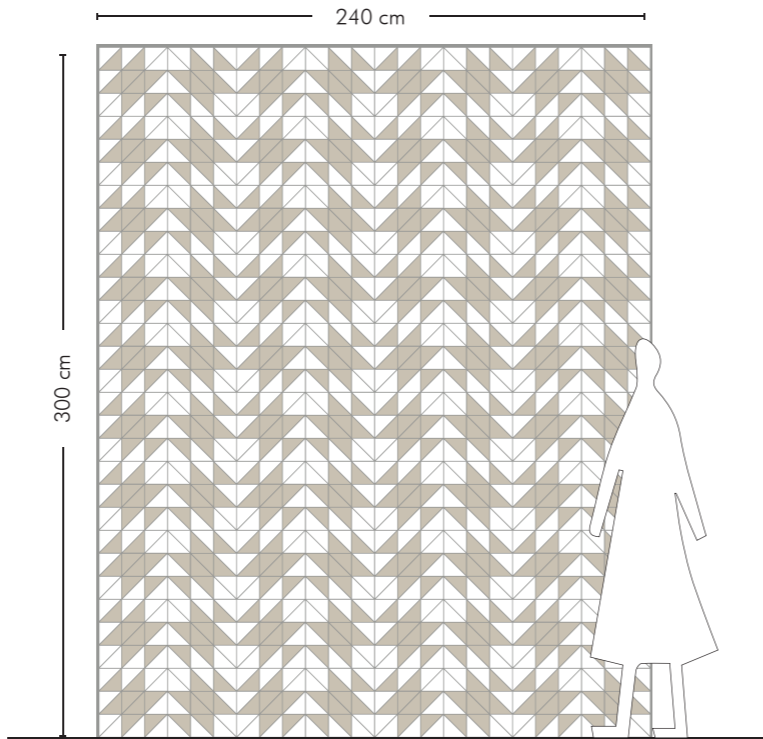

POSA B

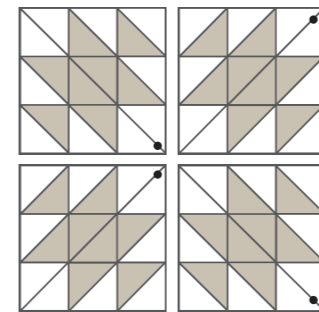

POSA D

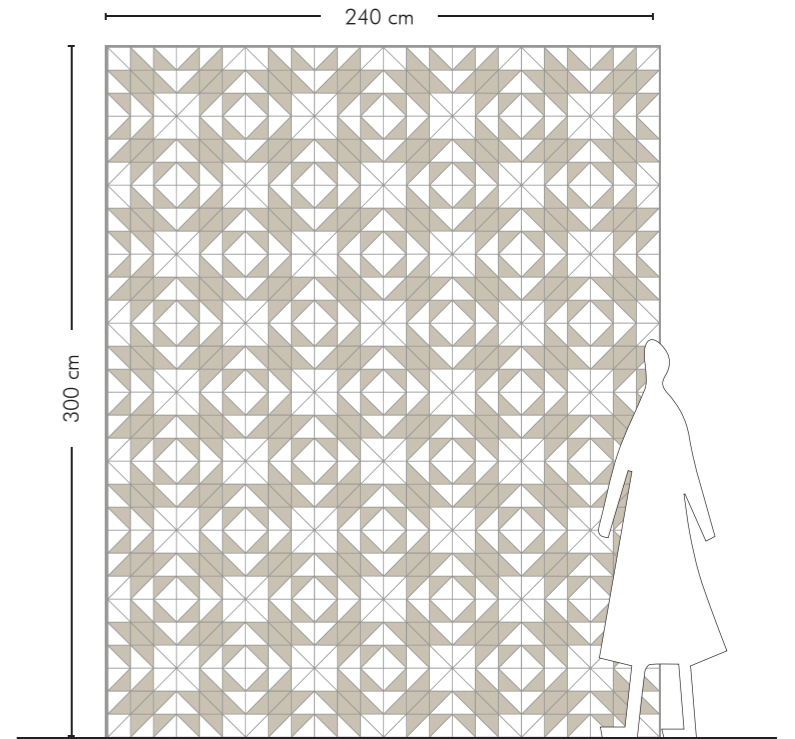

POSA D

SYSTEM DECOR 2

SCHEMI DI POSA
INSTALLATION CONFIGURATIONS
SCHÉMAS DE POSE
VERLEGESCHEMAS

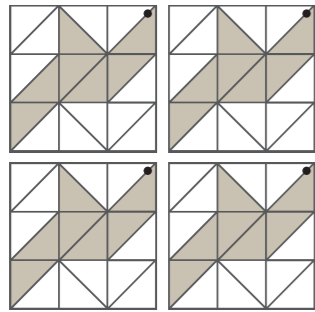

POSA A (PAG. 4-5)

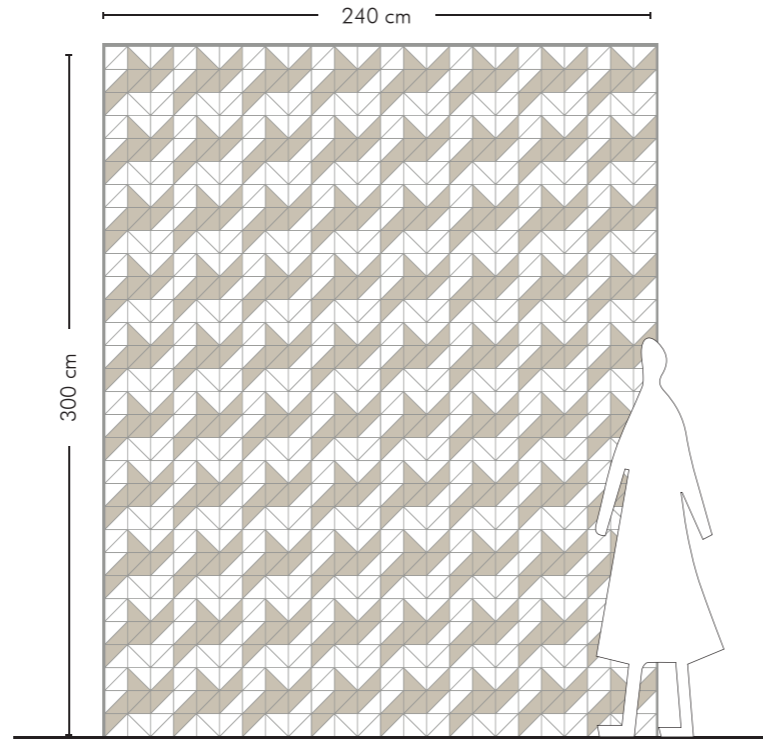

POSA A (PAG. 26-27)

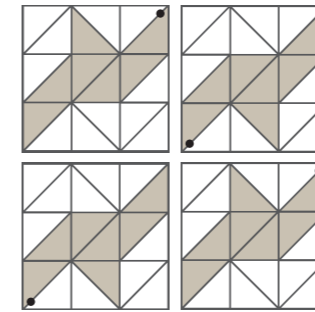

POSA C

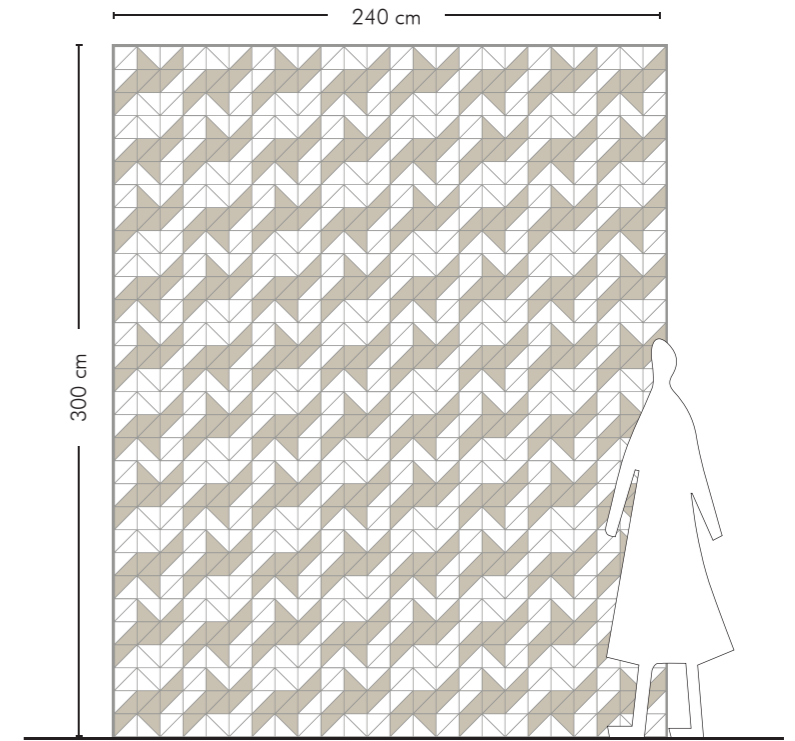

POSA C

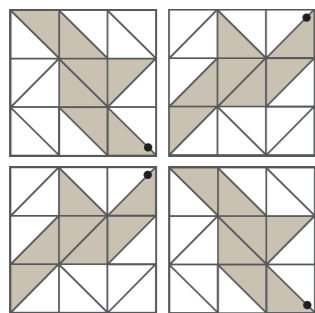

POSA B

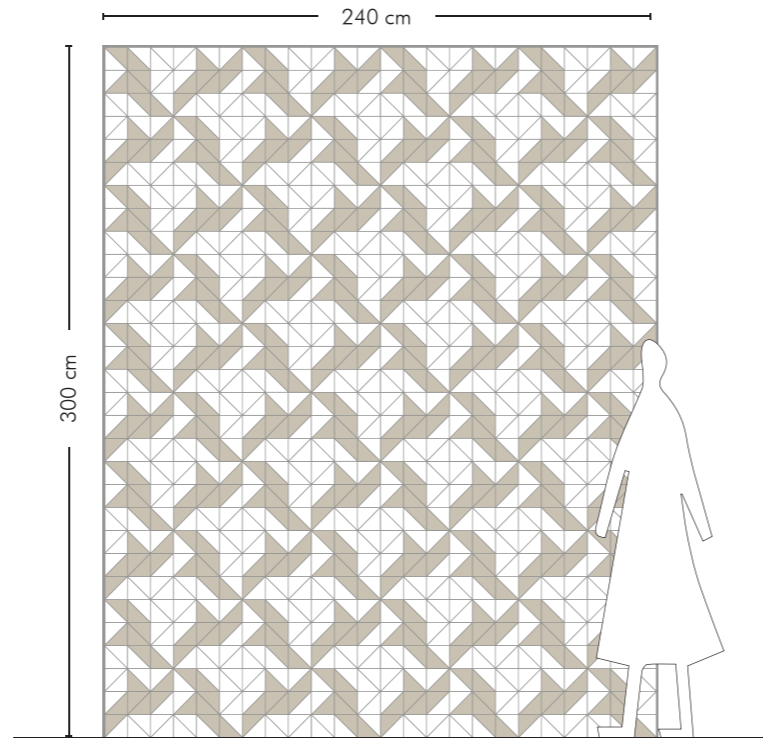

POSA B

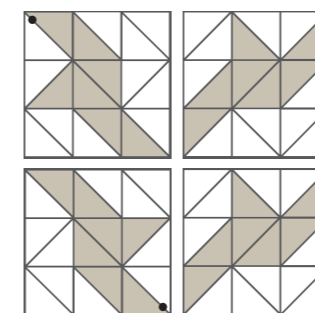

POSA D

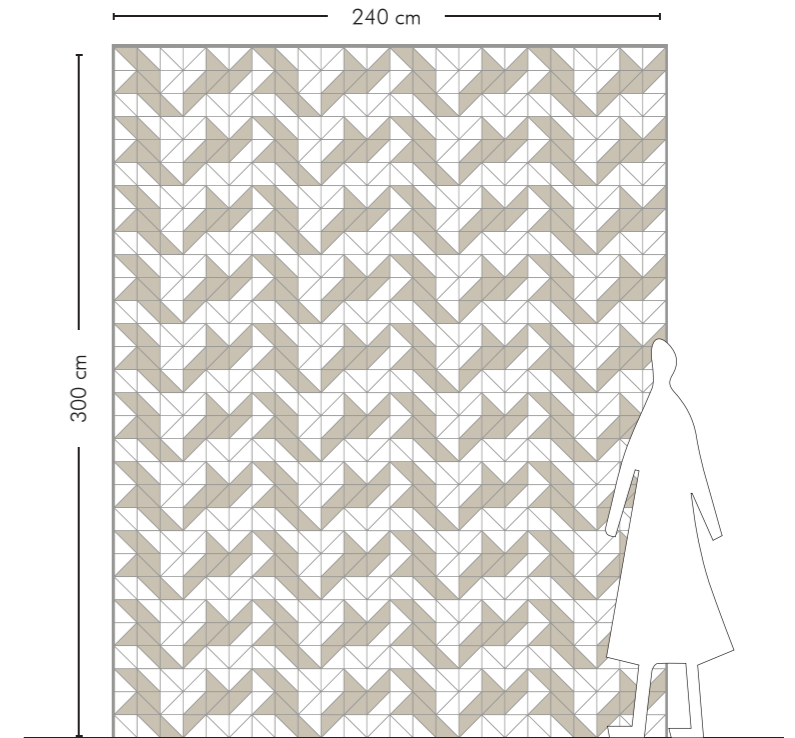

POSA D

SCHEDE TECNICHE

TECHNICAL CHARTS

FICHES TECHNIQUES

TECHNISCHE INFORMATIONEN

Voci di capitolato / Tender specifications / Détail des appels d'offre / Ausschreibungstext

Piastrelle di ceramica pressate a secco con basso assorbimento di acqua (0,5% < Eb ≤ 3%) Gruppo B1b - M - GL EN 14411:2016 appendice H.
Glazed ceramic tiles, dry pressed with low water absorption (0,5% < Eb ≤ 3%) Group B1b - M - GL EN 14411:2016 H appendix.
Carreaux ceramiques émaillés, pressés à sec à faible absorption d'eau (0,5% < Eb ≤ 3%) Groupe B1b - M - GL EN 14411:2016 annexe H.
Keramische glasierte Fliesen, trockengepresst, geringer Wasseraufnahme (0,5% < Eb ≤ 3%) Gruppe B1b - M - GL EN 14411:2016 H Anhang.

Commenti:

La modularità e le caratteristiche dimensionali delle piastrelle Ceramica Vogue presentano valori decisamente migliorativi rispetto alle prescrizioni delle norme, che ottimizzano il risultato estetico riducendo al contempo i costi di posa. Vogue è un prodotto facile da posare. I test relativi alle proprietà chimiche confermano che i prodotti di Ceramica Vogue forniscono prestazioni elevate per quanto riguarda la facilità di manutenzione, resistenza alle macchie, igienicità. In caso di particolari esigenze relative alla resistenza chimica, sono disponibili, a richiesta, test specifici.

Remarks:

Modularity and dimensional characteristics of the Ceramica Vogue ceramic tiles are definitely over the prescriptions of the norms, enhancing the aesthetical effect and reducing at the same time the laying costs. The Vogue product is easy to lay. The tests about chemical properties confirm high performances of the Ceramica Vogue products concerning an easy maintenance, resistance to stains, hygienic conditions. In case of particular requests concerning the chemical resistance, specific tests are available on demand.

Commentaires:

La modularité et les caractéristiques dimensionnelles des carreaux Ceramica Vogue présentent des valeurs nettement au-dessus des prescriptions des normes, afin d'optimiser le résultat esthétique en réduisant en même temps les coûts de pose. Vogue est donc un produit facile à poser. Les tests relatifs aux propriétés chimiques confirment que Ceramica Vogue donne des prestations élevées en ce qui concerne la facilité d'entretien, résistance aux taches, hygiène. Pour des nécessités spécifiques aux résistances chimiques, les tests spécifiques sont disponibles sur demande

Hinweise:

Die Modularität sowie die charakteristischen Dimensionen der Ceramica Vogue fliesen sind hochwertig und übersteigen die erforderlichen Normwerte, optimieren das esthetische Verlegebild und sind nicht so verlegkostenintensiv. Voguefliesen sind einfach zu verlegen! Die Prüfungsergebnisse der Säureteste bestätigen daß die Ceramica Vogue eine hohe Resistenz gegen Flechenbildung aufweist und somit einfach in der Pflege, Reinigung und Hygiene ist. Sofern besondere Eigenschaften hinsichtlich divv. chemischen Reaktionen gefordert werden, liegen auf Abruf, spezielle Testergebnisse vor.

Conformità alla Normativa

Il materiale Ceramica Vogue (prima scelta) è conforme a quanto previsto dalla normativa UNI EN 14411-2012 - Appendice H. Il sistema di gestione applica quanto previsto dalle Norme della Serie ISO 9000, ISO 14000 e dal Regolamento CE761/2001 EMAS. L'intero ciclo produttivo è dotato di Autorizzazione Integrata Ambientale, ai sensi dell'art. 4 D.Lgs 372/99 (I.P.P.C)

Conformity to Standards

Ceramica Vogue material (best quality) complies with the provisions of standard UNI EN 14411-2012 - Appendix H. The management system applies the provisions of the Standards in the series ISO 9000, ISO 14000 and the CE761/2001 EMAS Regulation. The whole production cycle is covered by an Integrated Environmental Authorisation, pursuant to Art. 4 of Italian Legislative Decree (D.Lgs) 372/99 (I.P.P.C)

Conformité à la Norme

Le matériau Ceramica Vogue (premier choix) est conforme aux dispositions de la norme UNI EN 14411-2012 - Annexe H. Le système de gestion applique les dispositions de la norme de la série ISO 9000, ISO 14000 et du Règlement CE 761/2001 EMAS. L'ensemble du cycle de production fait l'objet d'une Autorisation Environnementale Intégrée en vertu de l'art. 4 du D.L. 372/99 (IPPC).



Konformität mit den Bestimmungen

Das Material von Ceramica Vogue (erste Wahl) entspricht den Vorgaben der Bestimmung UNI EN 14411-2012 - Anhang H. Das Managementsystem wendet die Vorgaben der Bestimmungen der Reihe ISO 9000, ISO 14000 und der Regelung CE 761/2001 EMAS an. Der gesamte Produktionszyklus ist mit integrierter Umweltgenehmigung gemäß Art. 4 der Gesetzesverordnung 372/99 ausgestattet (I.P.P.C)

Dimensioni e qualità della superficie / Dimensions and surface quality / Dimensions et qualité de la surface / Abmessungen und Qualität der Oberfläche

formato nominale nominal shape format nominal Nennmaße	dimensione di fabbricazione actual size format réel effektive Maße	metodo di prova test methods méthode d'essai Prüfverfahren	requisiti requirements exigences Anforderungen
10x10x14 cm	lati - sides côtés - Seiten: 98,2x98,2x138,8 mm spessore - thickness épaisseur - Stärke: 7 mm	EN ISO 10545-2	lati - sides Seiten côtés: ± 0,9 mm spessore - thickness épaisseur - Stärke: ± 0,5 mm
Rettilineità dei lati (superficie di esercizio) - Straightness of sides (working surface) - Côtés rectilignes (surface d'utilisation) - Geradheit der Seiten (Betriebsfläche)		EN ISO 10545-2	± 0,5%
Ortogonalità - Squareness - Orthogonalité - Rechtwinkligkeit		EN ISO 10545-2	± 0,5%
Planarità della superficie - Flatness - Planéité - Ebenflächigkeit		EN ISO 10545-2	± 0,5%
Qualità della superficie - Surface quality - Qualité de la surface - Oberflächenbeschaffenheit		EN ISO 10545-2	min. 95%

Proprietà chimiche / Chemical properties / Propriétés chimiques / Chemische Eigenschaften

prova test essai Prüfungen	metodo di prova test methods méthode d'essai Prüfverfahren	requisiti requirements exigences Anforderungen	risultati Vogue Vogue results résultats Vogue Vogue Ergebnisse
 Resistenza alle macchie - Stain resistance - Résistance aux taches - Fleckenbeständigkeit	EN ISO 10545-14	classe 3 min.	3 min. (vedi appendice P) - (see P appendix) - (voir l'annexe P) - (sehen Sie P Anhang)
 Resistenza ai prodotti chimici d'uso domestico ed agli additivi per piscina - Resistance to chemical products for housekeeping and to the additives used in swimming-pools - Résistance aux produits de nettoyage pour la maison et aux additifs utilisés dans les piscines - Beständigkeit gegen Hausreinigungsmittel und gegen die in Schwimmbecken verwendeten chemischen Zusätze	EN ISO 10545-13	GB min.	GB min.
 Resistenza ad acidi e basi a bassa concentrazione - Resistance to acids and bases at low concentrations - Résistance aux acides et basiques à faible concentration - Beständigkeit gegen Säuren und Basen niedriger Konzentration	EN ISO 10545-13	indicata dal produttore indicated by the producer indiquée par le producteur vom Hersteller angegeben	GLB min.
 Resistenza ad acidi e basi ad alta concentrazione - Resistance to acids and bases at high concentrations - Résistance aux acides et basiques à concentration élevée - Beständigkeit gegen Säuren und Basen hoher Konzentration	EN ISO 10545-13	metodo di prova disponibile test method available méthode d'essai disponible Prüfverfahren vorhanden	GHB min.
 Cessione di piombo e cadmio - Lead and cadmium losses - Perte de plomb et cadmium - Abgabe von Pb und Cd	EN ISO 10545-15	metodo di prova disponibile test method available méthode d'essai disponible Prüfverfahren vorhanden	disponibile a richiesta - available if required - disponible sur demande - vorhanden wenn erforderlich











SCHEDE TECNICHE

TECHNICAL CHARTS



FICHES TECHNIQUES

TECHNISCHE INFORMATIONEN

Proprietà fisiche / Physical properties / Propriétés physiques / Physikalische Eigenschaften

prova test essai Prüfungen	metodo di prova test methods méthode d'essai Prüfverfahren	requisiti minimi minimum requirements exigences minimale Mindestanforderungen	risultati Vogue Vogue results résultats Vogue Vogue Ergebnisse
 Massa d'acqua assorbita (%) - Water absorption (%) - Masse d'eau absorbée (%) - Wasseraufnahme (%)	EN ISO 10545-3	0,5% < Eb ≤ 3,0 %	0,5% < Eb ≤ 3,0 %
 Resistenza di rottura Tensile strength Résistance aux ruptures Bruchfestigkeit	spessore - thickness - épaisseur - Stärke: ≥ 7,5 mm	EN ISO 10545-4	1.100 N min.
	spessore - thickness - épaisseur - Stärke: < 7,5 mm	EN ISO 10545-4	700 N min.
 Modulo di rottura - Modulus of rupture - Module de rupture - Biegefestigkeit	EN ISO 10545-4	30 N/mm2 min.	30 N/mm2 min.
 Resistenza all'abrasione (P.E.I.) - Abrasion resistance (P.E.I.) - Résistance à l'abrasion (P.E.I.) - Abriebbeständigkeit (P.E.I.)	EN ISO 10545-7	riportare la classe di abrasione - quote the abrasion class - donner la classe d'abrasion - geben Sie die Abnutzung Kategorie	vedi pagina prodotto - refer to product page - voir page produit - siehe Produktseite
 Coefficiente di dilatazione termica lineare Coefficient of linear thermal expansion - Coefficient de dilatation thermique linéaire - Lineare Wärmeausdehnungskoeffizient	EN ISO 10545-8	metodo di prova disponibile test method available méthode d'essai disponible Prüfverfahren vorhanden	< 6,9x10 ⁻⁶ /°C
 Resistenza agli sbalzi termici - Thermal shock resistance - Résistance aux chocs thermiques - Temperaturweschselbeständigkeit	EN ISO 10545-9	metodo di prova disponibile test method available méthode d'essai disponible Prüfverfahren vorhanden	garantita - guaranteed - garantiert - garantie
 Resistenza al cavillo - Crazing resistance - Résistance au tressillage - Haarrissbeständigkeit	EN ISO 10545-11	richiesta - required demandé - gefordert	garantita - guaranteed - garantiert - garantie
 Resistenza al gelo - Frost resistance - Résistance au gel Frostbeständigkeit	EN ISO 10545-12	metodo di prova disponibile test method available méthode d'essai disponible Prüfverfahren vorhanden	garantita (escluso pezzi speciali - trims excepted - à l'exception des pièces spéciales - ausser Formstücke)
 Dilatazione dovuta all'umidità - Expansion to humidity - Dilatation à l'humidité - Ausdehnung bei Feuchtigkeit	EN ISO 10545-10	metodo di prova disponibile test method available méthode d'essai disponible Prüfverfahren vorhanden	< 0,04%
 Resistenza all'urto - Impact resistance - Résistance au choc - Impaktbeständigkeit	EN ISO 10545-5	metodo di prova disponibile test method available méthode d'essai disponible Prüfverfahren vorhanden	> 0,6 (vedi appendice P) - (see P appendix) - (voir l'annexe P) - (sehen Sie P Anhang)

Altre prove / Other tests / Autres essais / Weiteren Prüfungen

prova test essai Prüfungen	metodo di prova test methods méthode d'essai Prüfverfahren	requisiti requirements exigences Anforderungen	risultati Vogue Vogue results résultats Vogue Vogue Ergebnisse
 Resistenza dei colori alla luce - Colour resistance to light - Résistance des couleurs à la lumière - Lichtfestigkeit der Farben	DIN 51094	non previsto - not foreseen pas prévu - nicht vorgesehen	garantita - guaranteed - garantie - garantiert
 Reazione al fuoco - Reaction to the fire - Réaction au feu - Reaktion bei Feuer	senza prova without test sans essai ohne Prüfung	decisione 96/603/CE decision 96/603/CE - décision 96/603/CE - Entscheidung 96/603/CE	classe A1

Marchatura CE

Il Regolamento Europeo 305/2011 (CPR) abroga la Direttiva 89/106/CEE sui prodotti da costruzione (CPD) introducendo dal 01/07/2013 alcune importanti novità nell'ambito della Marchatura CE dei prodotti da costruzione.

La Dichiarazione di Conformità dei prodotti da costruzione viene sostituita dalla Dichiarazione di Prestazione (DoP) con diverso significato e contenuto.

In assenza di questa dichiarazione i prodotti non possono circolare all'interno dei confini dell'Unione Europea.

La presenza del marchio CE su tutti gli imballi di Ceramica Vogue attesta che, il prodotto in essi contenuto è conforme a quanto dichiarato nelle schede tecniche, e la costanza delle prestazioni del prodotto è stata verificata ed attestata a garanzia dell'utilizzatore.

CE mark

European Regulation 305/2011 (CPR) abrogates Directive 89/106/EEC concerning construction products, introducing a number of important changes concerning the CE mark on construction products effective 01/07/2013.

The Declaration of Conformity for construction products is replaced by the Declaration of Performance (DoP), with a different meaning and different content.

Products cannot circulate within the European Union without this declaration.

The presence of the CE mark on all Ceramica Vogue packages demonstrates that the product contained in them conforms to the declarations of the technical information sheets and that the constancy of the product's performance has been tested as a guarantee for the user.

Symbole CE

Le règlement européen 305/2011 (CPR) abroge la directive 89/106/CEE sur les produits de construction (CPD) en introduisant depuis le 01/07/2013 certaines nouveautés importantes dans le cadre du symbole CE des produits de construction.

La déclaration de conformité des produits de construction est remplacée par la déclaration de prestation (DoP) avec un sens et un contenu différents.

En l'absence de cette déclaration, les produits ne peuvent pas circuler dans le territoire de l'Union Européenne.

La présence du symbole CE sur tous les emballages de Ceramica Vogue atteste que le produit qu'ils contiennent est conforme à ce qui est déclaré sur les fiches techniques, et que la constance des prestations du produit a été vérifiée et attestée comme garantie pour l'utilisateur.

CE -Kennzeichnung

Die europäische Regelung 305/2011 (BPR) ersetzt die Richtlinie 89/106/EWG hinsichtlich Bauprodukten, indem ab dem 01.07.2013 einige wichtige Neuheiten im Rahmen der CE -Kennzeichnung der Bauprodukte eingeführt werden.

Die Konformitätserklärung der Bauprodukte wird von der Leistungserklärung (LE) mit anderer Bedeutung und anderem Inhalt abgelöst.

In Ermangelung dieser Erklärung dürfen die Produkte innerhalb der Grenzen der EU nicht mehr in Umlauf gebracht werden.

Das Vorliegen des CE -Zeichens auf allen Verpackungen von Ceramica Vogue bescheinigt, dass das darin enthaltene Produkt den Erklärungen in den technischen Datenblättern entspricht und dass die Konstanz der Leistungen des Produkts als Garantie des Benutzers überprüft und bescheinigt wurde.

Determinazione della pulibilità e analisi microbatterica

I materiali di Ceramica Vogue, previa accurata pulizia con prodotti specifici, non favoriscono il proliferare dei batteri (prova di laboratorio disponibile).

Determination of cleanability and microbacterial analysis

Ceramica Vogue materials, if properly cleaned with appropriate cleaning products, do not promote the proliferation of bacteria (laboratory tests available).

Détermination de la nettoyabilité et analyse microbactérienne

Les matériaux de Ceramica Vogue, grâce à un nettoyage soigné avec des produits adaptés, ne favorisent pas la prolifération des bactéries (test de laboratoire disponible).

Bestimmung der Reinigbarkeit und mikrobiologische Analyse

Die Materialien von Ceramica Vogue, wenn gründlich mit spezifischen Produkten gereinigt, begünstigen nicht die Bakterienverbreitung (Laborprobe verfügbar).

SCHEDE TECNICHE

TECHNICAL CHARTS

FICHES TECHNIQUES

TECHNISCHE INFORMATIONEN

Manutenzione e pulizia

La qualità di un rivestimento in piastrelle ceramiche dipende, oltre che da una buona progettazione e da una corretta posa, anche dalla cura che verrà rivolta alle superfici.

Le piastrelle Ceramica Vogue in grès smaltato in pasta bianca ingelivo sono resistenti, igieniche e facili da pulire, non richiedono particolari cure ma solo l'applicazione di alcune elementari norme di pulizia. È importante distinguere tra pulizia di fine cantiere e pulizia ordinaria.

Pulizia di fine cantiere

Oltre a mantenere sempre protette le superfici durante la fasi di cantiere, è di fondamentale importanza curare la prima pulizia.

Questa operazione ha lo scopo di eliminare ogni traccia e residuo di posa dalla superficie delle piastrelle. Prima del lavaggio è importante rimuovere con un aspiratore lo sporco grossolano evitando di rigare la superficie delle piastrelle. La pulizia deve essere fatta con prodotti in commercio tipo Deterdek Pro (www.filachim.com), Keranet (www.mapei.com) o prodotti similari. Si raccomanda di seguire rigorosamente le indicazioni riportate sulle schede tecniche dei prodotti utilizzati e comunque di fare delle prove dei prodotti di pulizia su una piccola porzione di una piastrella prima di eseguire la pulizia totale della superficie.

Pulizia ordinaria

Per la pulizia ordinaria è bene usare prodotti in grado di eliminare eventuali macchie di sporco senza però intaccare la smaltatura superficiale, evitare quindi sostanze molto aggressive quali prodotti a base acida.

Usare semplici prodotti adatti alla pulizia della ceramica. Per migliorare l'efficacia dei detergenti diluirli con acqua calda.

Norme generali

Sostanze abrasive o strumenti per la pulizia quali spugne abrasive o spazzole eccessivamente dure sono sconsigliati in quanto potrebbero provocare sulla superficie delle piastrelle graffi o segni impossibili poi da eliminare.

Sui prodotti con caratteristiche antiscivolo evitare assolutamente l'utilizzo di prodotti lavaincera o cere.

Nel caso di locali comunicanti con l'esterno è indispensabile utilizzare zerbini per ridurre l'apporto di agenti abrasivi.

Maintenance

The quality of a ceramic wall tile depends not only on proper design and laying, but also the care taken of the surface thereafter.

Ceramica Vogue frost resistant white body glazed stoneware tiles are hard-wearing, hygienic and easy to clean. They require no particular maintenance other than the application of a number of simple cleaning rules.

It is important to distinguish between the cleaning to be carried out when the building work is complete and ordinary cleaning.

Cleaning after building work is completed

In addition to keeping surfaces protected during the various phases of the building work, it is of fundamental importance to ensure the tiles are cleaned properly for the first time once the building work is complete.

The purpose of this operation is to remove all traces and residue from the laying process from the surface of the tiles. Before washing the tiles, it is important to vacuum off the worst of the dirt, without scratching the surface of the tiles. Cleaning must be done using products such as Deterdek Pro (www.filachim.com), Keranet (www.mapei.com) or similar.

The indications on the technical specifications of the products used must be followed very carefully, and all cleaning products should be tested on a small portion of a tile before proceeding to clean the whole surface.

Ordinary cleaning

For ordinary cleaning, it is best to use products able to remove any dirty marks without damaging the surface glaze, avoiding particularly aggressive (e.g. acid-based) products.

Use simple products suitable for cleaning ceramics. To improve the efficacy of the cleaning agents, dilute them in hot water.

General rules

Abrasive substances or cleaning instruments such as abrasive sponges or excessively hard brushes should be avoided, because they could scratch the surface or leave marks that will be impossible to remove.

On products with anti-slip characteristics, wash and wax or wax products must not be used.

For areas that lead directly outdoors, mats must be used in order to limit the abrasive agents brought in.

Entretien et nettoyage

Au-delà d'une conception intelligente et d'une pose dans les règles de l'art, la qualité d'un revêtement céramique dépend aussi du soin qui sera apporté aux surfaces. Les carrelages Ceramica Vogue en grès émaillé à pâte blanche ingélif sont résistants, hygiéniques et faciles à nettoyer. Ils n'exigent aucun soin particulier, seulement quelques règles élémentaires de propreté. Il est important de faire la différence entre le nettoyage de fin de chantier et le nettoyage ordinaire.

Nettoyage de fin de chantier

En plus de protéger les surfaces pendant toute la durée du chantier, il est fondamental de soigner le premier nettoyage.

Cette opération a pour but d'éliminer toute trace et résidu de pose présent à la surface du carrelage. Avant de procéder au lavage, il est important de passer l'aspirateur afin d'éliminer la saleté pour éviter de rayer les carreaux. Effectuer ensuite le nettoyage à l'aide de produits disponibles dans le commerce tels que Deterdek Pro (www.filachim.com), Keranet (www.mapei.com) ou tout autre produit similaire.

Il est recommandé de suivre rigoureusement les indications figurant sur les fiches techniques des produits utilisés et, quoi qu'il en soit, de procéder à un essai sur une petite surface avant de passer au nettoyage du carrelage dans sa totalité.

Nettoyage ordinaire

Pour le nettoyage ordinaire, il est préférable d'utiliser des produits en mesure d'éliminer toute trace éventuelle de saleté sans abîmer l'émail des carreaux. Les substances très agressives, à base acide notamment, sont donc à éviter.

Utiliser les produits habituellement conseillés pour nettoyer le carrelage. Pour améliorer l'efficacité des détergents, vous pouvez les diluer dans de l'eau chaude.

Normes générales

Les substances abrasives, les éponges abrasives ou encore les brosses excessivement dures sont déconseillées car elles risquent de rayer la surface des carreaux ou de laisser des traces qui pourraient s'avérer impossible à éliminer.

Sur les produits antidérapants, éviter absolument d'utiliser des produits lavants-cirants ou des cires.

Si le carrelage est posé sur des pièces qui communiquent avec l'extérieur, il est indispensable d'utiliser des tapis-brosses afin de limiter l'apport d'agents abrasifs.

Pflege und Reinigung

Die Qualität einer Verkleidung aus Keramikfliesen ist neben einer guten Planung und korrekten Verlegung auch von der Pflege abhängig, die den Oberflächen gewidmet wird.

Die Fliesen Ceramica Vogue aus frostbeständiges weißscherbiges glasiertes Gres-Steinzeug lackiertem Steingut sind resistent, hygienisch und leicht zu reinigen. Sie erfordern keine besondere Pflege sondern nur die Berücksichtigung einiger grundsätzlichen Reinigungsregeln. Es ist wichtig, zwischen der Baustellenreinigung und einer normalen Reinigung zu unterscheiden.

Baustellenreinigung

Die Oberflächen müssen während der Bauphase immer geschützt bleiben und außerdem ist es von absoluter Wichtigkeit, dass die erste Reinigung sorgfältig durchgeführt wird.

Hierzu müssen alle Spuren und Reste der Verlegung von den Fliesenoberflächen entfernt werden. Vor der Reinigung mit einem Staubsauger den groben Schmutz entfernen, dabei darauf achten, dass die Fliesenoberflächen nicht zerkratzt werden. Die Reinigung mit handelsüblichen Produkten, wie Deterdek Pro (www.filachim.com), Keranet (www.mapei.com) oder ähnlich durchführen.

Es wird empfohlen, die Angaben auf den Datenblättern der verwendeten Produkte genau zu befolgen und in jedem Fall das Produkt auf einem kleinen Fliesenbereich zu testen, bevor die gesamte Fläche gereinigt wird.

Normale Reinigung

Für die normale Reinigung sollten Produkte verwendet werden, die eventuelle Flecken entfernen ohne die Glasur der Oberfläche anzugreifen - keine aggressiven oder säurehaltigen Mittel verwenden.

Einfache Produkte zur Fliesenreinigung verwenden. Für eine bessere Wirkung die Reinigungsmittel in heißem Wasser verdünnen.

Allgemeine Hinweise

Von Scheuermitteln oder Reinigungsgeräten, wie Scheuerschwämme oder harten Bürsten wird abgeraten, da sie die Oberfläche der Fliesen zerkratzen oder andere nicht entfernbare Spuren hinterlassen können.

Auf Produkten mit rutschhemmenden Eigenschaften dürfen auf keinen Fall wachshaltige Reinigungsmittel oder Bohnerwachs verwendet werden. In Bereichen mit externem Zugang muss eine Matte verwendet werden, um die Verunreinigung mit scheuernden Komponenten zu verringern.



www.ceramicavogue.it

made in italy

Progetto ambienti interni: Marcante - Testa
Produzione immagini e styling: Terzo Piano
Fotolito e stampa: Ingraph
Ufficio stampa: info@sabrinagiacchetti.it
Stampato in Italia Maggio 2021

Ceramica VOGUE
è un marchio di



Socio Ordinario
del GBC Italia



Ceramics of Italy



Ceramica VOGUE
Via Papa Giovanni XIII, 100 - Loc. Vergnasco
13882 Cerrione (BI) ITALIA
T. +39.015.672.1
Fax +39.015.671.626 (Italia)
Fax +39.015.671.352 (Export)
info@cervogue.com

Ceramica
VOGUE

TILES FOR ARCHITECTURE